

## **FORWARD OSMOSIS – A BRIEF INTRODUCTION**

**Author:** Peter G. Nicoll  
Technical Director – Modern Water plc – United Kingdom  
peter.nicoll@modernwater.co.uk

### **Abstract**

Forward Osmosis (FO) over the past five years has generally attracted more attention, both academically and commercially, with a number of companies raising finance on the back of its potential. The process exploits the natural process of osmosis, which is how plants and trees take up water from the soil – a low energy, natural process. It works by having two solutions with different concentrations (or more correctly different osmotic pressures) separated by a selectively permeable membrane, in the case of the plants and trees their cell walls, and ‘pure’ water flows from less concentrated solution across the membrane to dilute the more concentrated solution, leaving the salts behind. The clue in the potential applications is that it is widely used in nature, however it is only relatively recently that its full potential has begun to be recognised industrially. It can be used on its own or in combinations with other processes, for example desalination, concentration and renewable power generation.



# I INTRODUCTION

Osmotically driven membrane processes (ODMPs) or forward osmosis (FO) processes may not currently be ‘main stream’, but it is apparent that they are increasingly becoming a topic of some interest. National Geographic [1] in an article in April 2010 cited it as one of the three most promising new desalination technologies and at the last IDA World Congress in Perth, Australia in 2011, six papers were published on this subject. In the Journal of Membrane Science the number of papers published has seen a very significant increase over the last three years (24 in 2012), showing the increasing level of academic interest. We have also seen the emergence of a number of commercial organisations with significant funding to develop and exploit the technology such as, Hydration Technology Innovations Inc, Modern Water plc, Oasys Water Inc, Statkraft AS and Trevi Systems Inc.

So why this interest in forward osmosis, or more simply just osmosis, given that it has been used in nature for rather a long time by, plants, trees, sharks and human cells to name just a few? It also takes place as drawback when a reverse osmosis plant shuts down and the permeate flows back across the membrane to dilute the feed solution, so this should give some clue as to its potential.

The process, just like reverse osmosis (RO), requires a selectively permeable membrane separating two fluids with different osmotic pressures and was first observed by Albert Nollet in 1748 [2]. If the solvent is water then effectively almost pure water flows from the fluid of lower osmotic pressure to dilute the fluid of higher osmotic pressure. The process in its pure form takes place at atmospheric pressure, with variations such as pressure enhanced osmosis and pressure retarded osmosis. These are simply illustrated in Figure 1.

**Figure 1: Osmotic Processes**

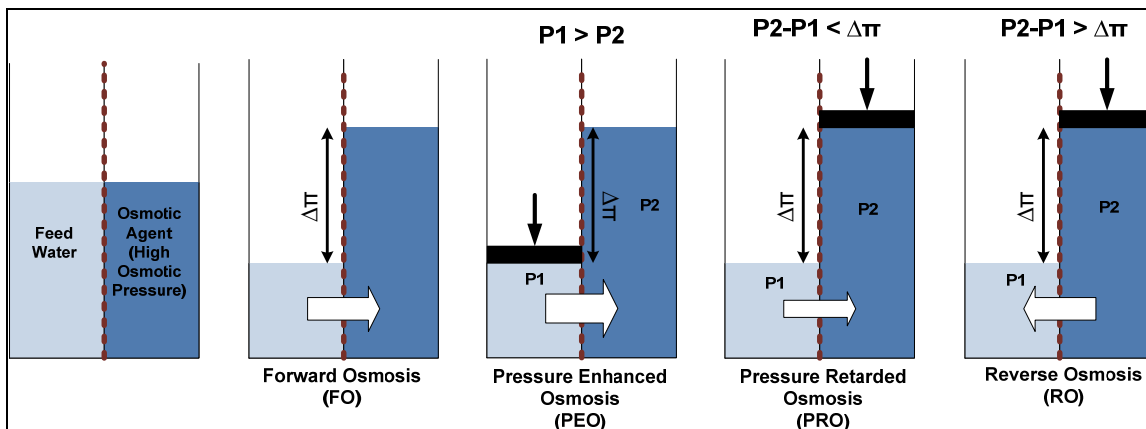

It is worth reminding ourselves just what forward osmosis can do:

- It can dilute a solution of higher osmotic pressure with a solution of lower osmotic pressure.
- It can concentrate a solution of lower osmotic pressure with a solution of higher osmotic pressure.

So why might this be useful? One key element is the dilution/concentration process takes place across a selectively permeable membrane, at low pressure and the ions are rejected in both the direction of forward flow and reverse flow. However in the case of FO there is diffusion of solutes in both directions and in the reverse direction we talk about back diffusion. The process is inherently less prone to fouling than pressure driven membrane processes and depending on how and if the osmotic agent / draw solution is recovered has a direct affect on the energy consumption of the overall process when it is fully integrated.

The process has considerable potential across a wide variety of applications; emergency drinks [3], power generation [4], enhanced oil recovery [5], produced water treatment [6], fluid concentration [7], thermal desalination feedwater softening [8], water substitution [9] and desalination [10]. However only a few of these applications have been currently commercialised; emergency drinks, produced water treatment, desalination and water substitution.

This paper outlines some of the aspects of this process and its derivatives, with regard to key issues, concepts and some applications.

## II BASIC PRINCIPLES

Forward osmosis, direct osmosis or just osmosis is the transport of a solvent (normally water) across a selectively permeable membrane from a region of lower osmotic potential to a region of higher osmotic potential. During this process the solute or solutes are rejected by the membrane, in the same way as a reverse osmosis membrane. The osmotic pressures of some common solutions are shown in Figure 2, for reference

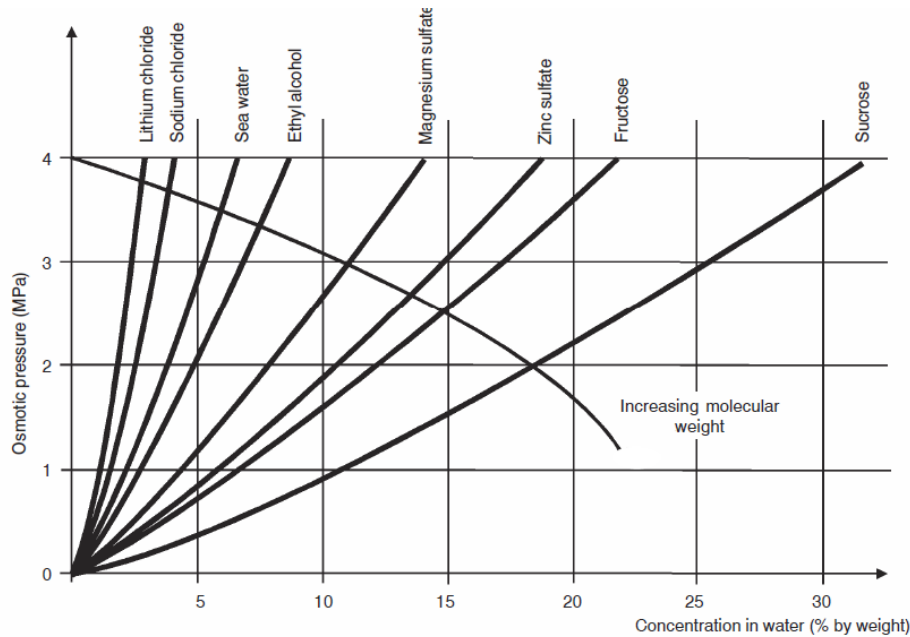

Figure 2: Osmotic pressures of various solutions. Taken from [11].

### 2.1 Solvent Transport

Solvent transport can be expressed as:

$$J_w = A(\Delta\pi - \Delta P) \quad (1)$$

Where  $J_w$  is the water flux across the membrane (in this case signed as positive in the direction of osmotic flow),  $A$  is the water permeability coefficient,  $\Delta\pi$  is the osmotic pressure difference across the membrane and  $\Delta P$  is the hydrostatic pressure difference.

Lee et al. [12] characterised various osmotic processes, defining Forward Osmosis (FO) when  $\Delta P = 0$ , Pressure Retarded Osmosis (PRO) as  $\Delta\pi > \Delta P$  and Reverse Osmosis (RO) when  $\Delta P > \Delta\pi$ . For practical purposes there are few situations where forward osmosis occurs with this definition (no applied hydraulic pressure on either side of the membrane) and more recently it is generally been assumed that FO relates to water treatment applications and PRO relates to osmotic power applications or applications where the membrane active layer faces the draw solution. What is not defined by Lee et al. is the case where hydraulic pressure is applied to the draw solution, Pressure Enhanced Osmosis (PEO) (or

Pressure Assisted Osmosis (PAO)). For the purposes of this paper Forward Osmosis is a general description given for all osmotically driven membrane processes (ODMPs).

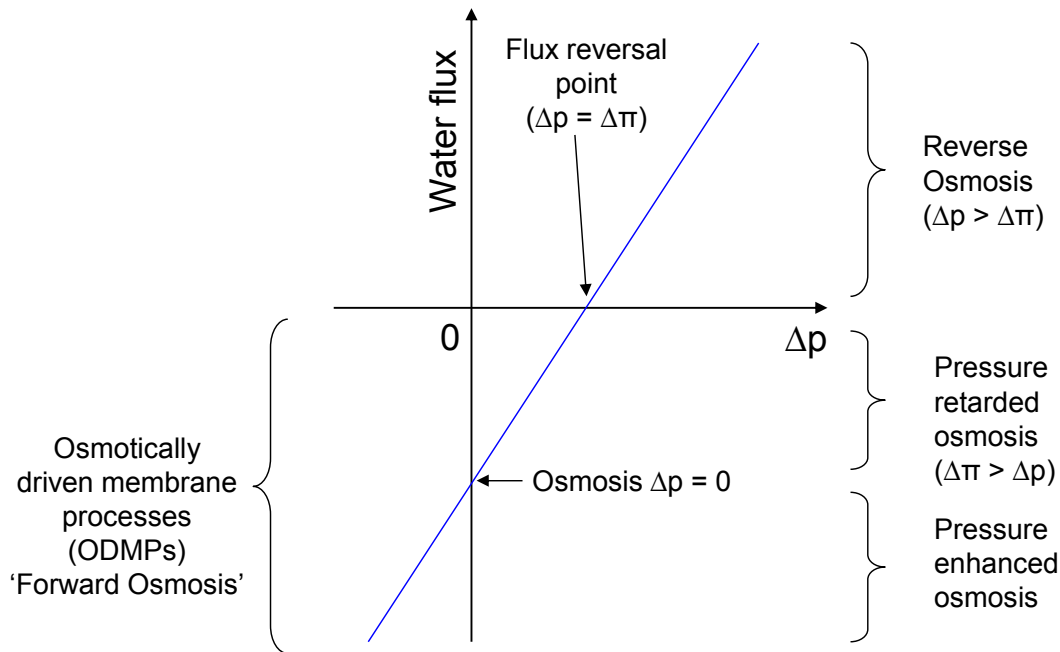

**Figure 3: Relationship between water flux, osmotic pressure differential and hydraulic pressure differential, showing the family of osmotic membrane process for an ideal semi-permeable membrane. Adapted from [12]**

## 2.2 Solute Transport

The solute flux ( $J_s$ ) for each individual solute can be modelled by Fick’s Law:

$$J_s = B\Delta c \tag{2}$$

Where  $B$  is the solute permeability coefficient and  $\Delta c$  is the trans-membrane concentration differential for the solute. It is clear from this governing equation that a solute will diffuse from an area of high concentration to an area of low concentration. This is well known in reverse osmosis where solutes from the feedwater diffuse to the product water, however in the case of forward osmosis the situation can be far more complicated.

In FO processes we may have solute diffusion in both directions depending on the composition of the draw solution and the feed water [13, 14]. This does two things; the draw solution solutes will diffuse to the feed solution and the feed solution solutes will diffuse to the draw solution. Clearly this phenomena has consequences in terms of the selection of the draw solution for any particular FO process. For instance the loss of draw solution may have an impact on the feed solution perhaps due to environmental issues or contamination of the feed stream, such as in osmotic membrane bioreactors. Conversely the draw solution may be contaminated from solutes that may foul or scale when the draw solution is recycled.

### 2.3 Concentration polarisation

This phenomenon and its impact on the net driving osmotic pressure is one of the most significant factors in osmotically driven processes, primarily because of the membrane support layer.

In forward osmosis the feedwater solution becomes more concentrated on one side of the membrane and the draw solution becomes more diluted at the other, this effectively reduces the differential osmotic pressure and therefore the solvent flow. The magnitude of these affects depends on the nature of the membrane and its orientation.

The solvent flux is described in Eq. (1) and the net driving osmotic pressure is in reality across the active layer of the membrane and not the bulk osmotic pressures of either the feed or draw solutions. It has been found that actual fluxes are significantly lower than that predicted from Eq. (1), which has been attributed to external concentration polarisation (ECP) which takes place on the dense layer and internal concentration polarisation (ICP) which takes place within the porous support layer, as illustrated in Figure 4. ICP is the most important consideration.

If the membrane is of the asymmetric type, with a support layer, then the support layer inhibits the affects of turbulence. If the feed solution faces the support layer the reduction in net driving osmotic pressure is accounted for by concentrative internal concentration polarisation and where the draw solution faces the support layer this phenomena is termed dilutive internal concentration polarisation.

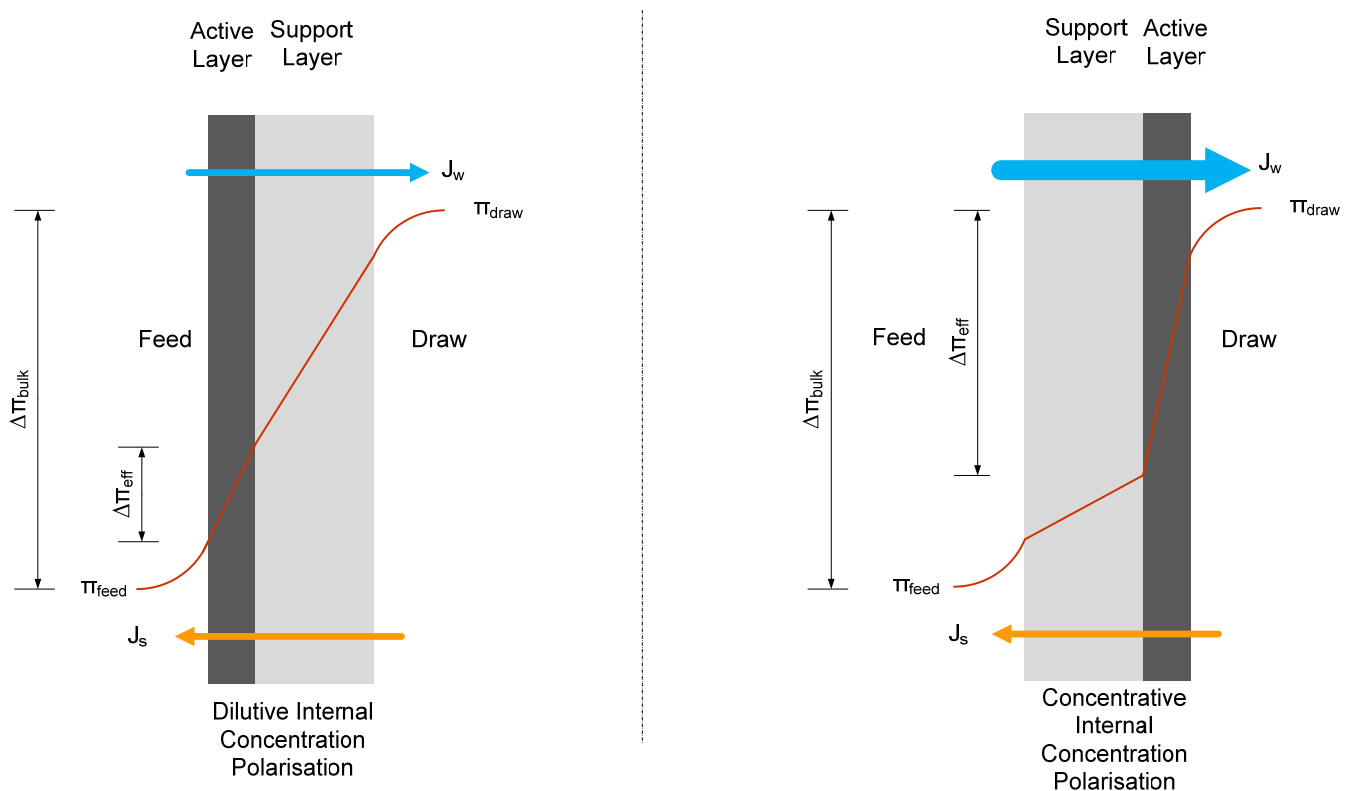

**Figure 4: Dilutive and concentration internal polarisation concentration**

Loeb et al. [15] introduced a simplified equation to model concentration polarisation based on the models that were developed by Lee et al. [12], for water fluxes in FO without consideration of the membrane orientation and any applied hydraulic pressure:

$$J_w = \frac{1}{K} \ln \frac{\pi_{Hi}}{\pi_{Low}} \quad (3)$$

Where  $K$  is the solute diffusion resistance within the membrane support layer,  $\pi_{Hi}$  and  $\pi_{Low}$  are the bulk osmotic pressures of the draw solution and feed solution respectively and  $K$  is defined as:

$$K = \frac{t\tau}{\varepsilon D_s} = \frac{S}{D_s} \quad (4)$$

Where  $t$  is the membrane thickness,  $\tau$  is the tortuosity,  $\varepsilon$  is the porosity,  $D_s$  is the diffusion coefficient for the solute and  $S$  is the structural parameter. The structural parameter ( $S$ ) is an important intrinsic parameter of the membrane in that it directly affects the magnitude of internal concentration polarisation and as such the magnitude of the flux. On this basis, thin, open structured membranes make better forward osmosis membranes than thick tortuous membranes. Further considerations to be modelled include the size of the solute molecules relative to the pore size, these and other factors are summarised by Zhao et al. [16].

### III MEMBRANE FOULING

This is a key differentiator between osmotically driven processes and reverse osmosis, which has been investigated by a number of academic researchers and reported by commercial organisations based on real operating experience. The general conclusion is that fouling under FO conditions is less than under a pressure drive RO process and moreover is often entirely reversible.

Cath et al. [17, 18] studied fouling in FO for long term space missions, where they reported there was no sign of flux reduction as a result of membrane fouling, thus giving the first indication of the low fouling propensity of the process.

Cornelissen et al. [14] used an osmotic membrane bio reactor system to treat activated sludge, where they reported that neither reversible nor irreversible fouling was observed when the membrane active layer was facing the sludge.

Lee et al. [19] reported in a comparison between forward osmosis and reverse osmosis organic fouling that organic fouling under FO conditions could be controlled entirely by increasing the cross flow velocity on a flat sheet membrane, while no noticeable change was observed for the RO system.

Holloway et al. [20] compared FO and RO membrane fouling (operating at the same initial flux rates) when investigating the concentration of anaerobic digester centrate. They reported that the rate of flux decline was higher with RO than FO and that the FO fouling was reversible, whereas the RO fouling was not. They further speculated that the reason for both the lower rate of fouling and its reversibility was due to the affects of hydraulic pressure on the foulants on the membrane surface, which occurs rapidly in RO.

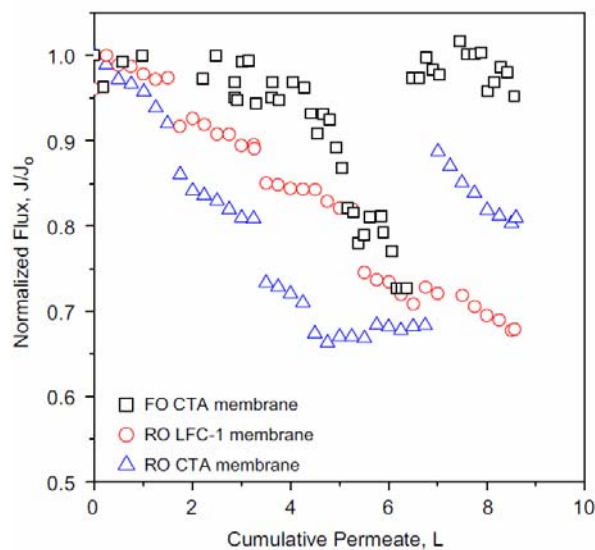

**Figure 5: Relative water flux as a function of water produced for three experiments, including one chemical clean each. Taken from [20].**



Thompson and Nicoll [10], compared a seawater reverse osmosis plant operating in parallel with a FO/RO desalination plant, using a common pre-treatment in Oman and also reported on a FO/RO plant in Gibraltar, where there was no requirement to chemically clean the FO/RO plant but there was in the case of the reverse osmosis plant. What was not reported by Thompson and Nicoll but was subsequently reported by Nicoll [21] was that the membrane active layer was on the seawater side of the membrane and the membrane was in a hollow fibre configuration.

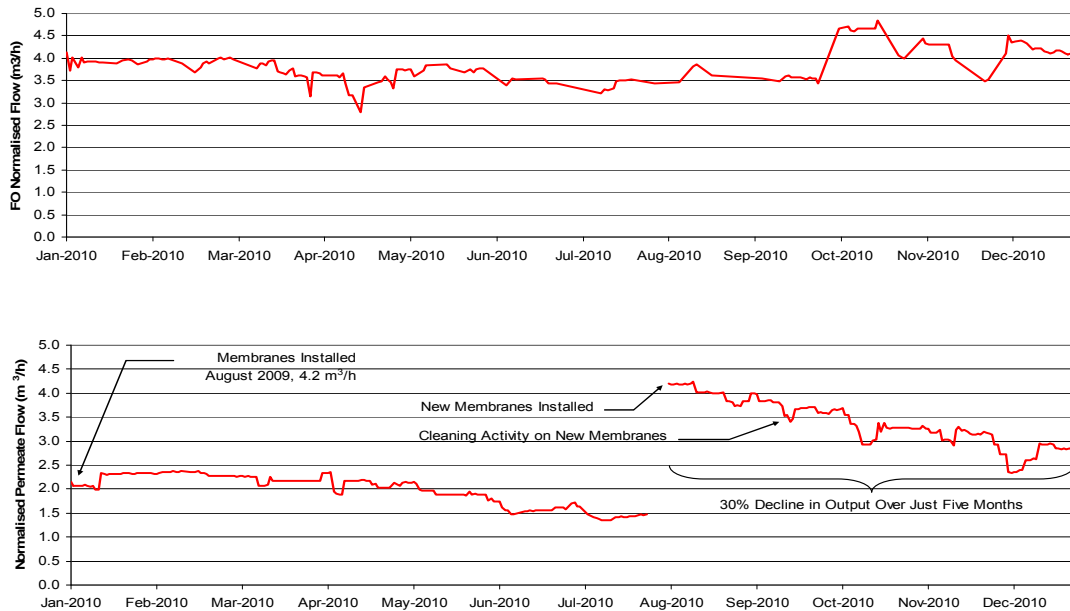

**Figure 6: Comparison of a FO membrane system and a RO membrane system operating on a common feed water. Taken from [10].**

The potential reasons for the lower fouling propensity were investigated by Lay et al. [22], where it was suggested that the low water fluxes, the use of hydrophilic and smooth membranes and the effect of internal concentration polarisation that is inherent to FO, were behind this phenomena.

There is much to understand, however it is clear that FO does have inherently lower fouling compared to reverse osmosis and it is this aspect where there is much potential when operating on extremely challenging feedwaters.

## IV APPLICATIONS

There are a wide range of applications that either have been put into practice, albeit on a relatively small scale and with relatively few real references or at lab scale, however we have seen in recent years a significant increase in the number of papers published both in peer and non peer reviewed form. Some of these are described with the aim of showing the diverse range of applications that forward osmosis processes may be deployed. Some of these are single step processes, where only forward osmosis is deployed with no recovery of the draw solution and others incorporate a recovery of the draw solution.

**Table 1: Commercial status – applications. Adapted and updated from [23]**

<b>Company</b>	<b>Primary Current Applications</b>	<b>Status</b>
Forward Water Technologies	Desalination	Development
Hydration Technology Innovations	Emergency drinks Frac water make-up / flow back water concentration	Commercial Commercial
IDE Technologies	Osmotic Power	Pre-commercial
Modern Water	FO/RO FO – cooling tower make-up Thermal desalination feed water softening	Commercial Commercial Development
Oasys Water	Brine concentration	Commercial
Statkraft	Osmotic Power	Pre-commercial
Trevi Systems	Desalination	Commercial

### 4.1 Osmotic power generation

In 1954 Pattle [24] suggested that there was an untapped source of power when a river mixes with the sea, in terms of the lost osmotic pressure, however it was not until the mid '70s where a practical method of exploiting it using selectively permeable membranes by Loeb [25] and independently by Jellinek [26] was outlined. This process was referred by Loeb as pressure retarded osmosis (PRO) and one implementation of it is shown in Figure 7. Some situations that may be envisaged to exploit it are using the differential osmotic pressure between a low brackish river flowing into the sea, or concentrated brines from a solar pond and seawater [27]. The worldwide theoretical potential for osmotic power has been estimated at 1,650 TWh / year [28].

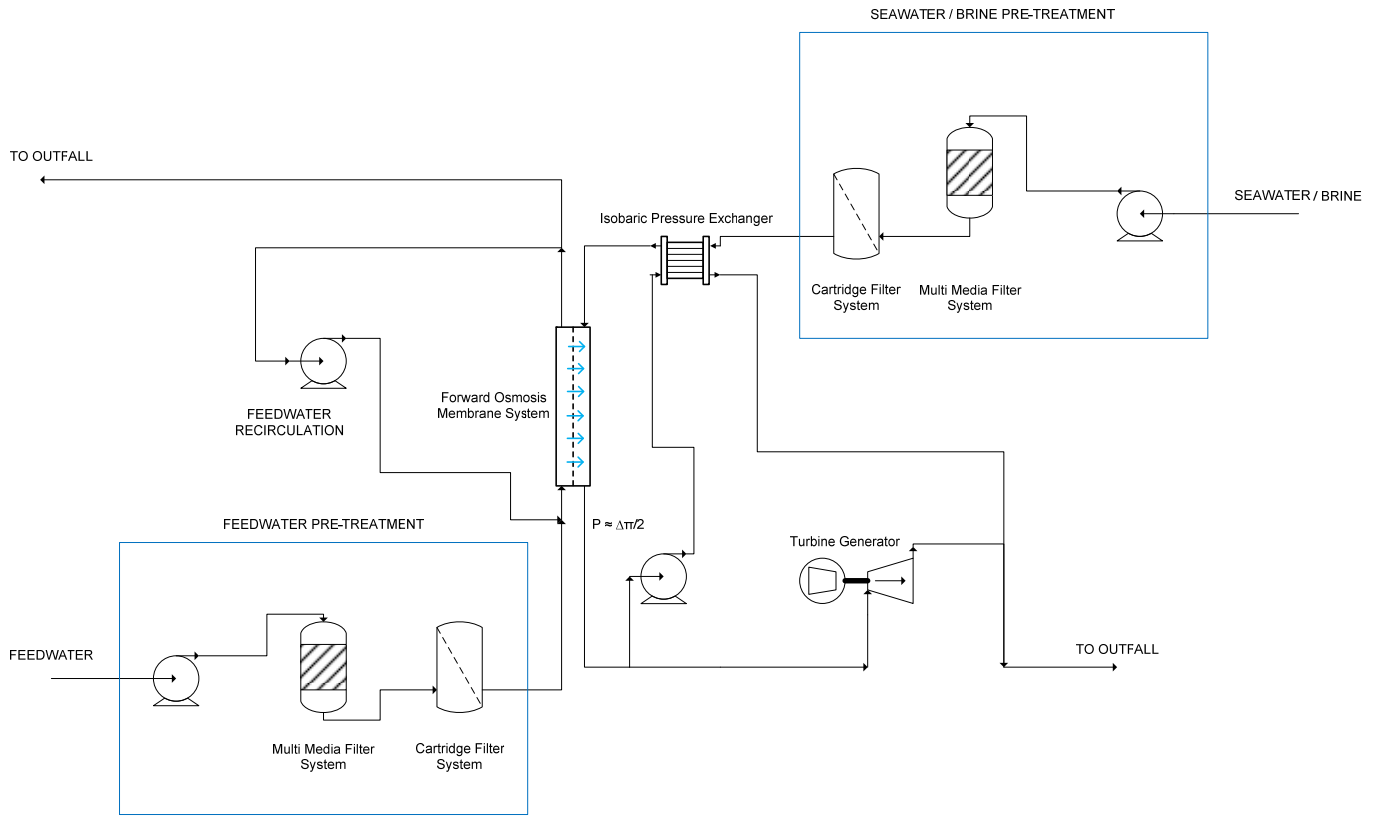

**Figure 7: PRO power plant incorporating pressure exchanger and feedwater recirculation**

The power that may be generated per unit of membrane area ( $W$ ) is the product of water flux and hydrostatic pressure of the higher osmotic pressure (saltier) solution:

$$W = J_w \Delta P = A(\Delta\pi - \Delta P)\Delta P \quad (5)$$

Differentiating equation (5) with respect  $\Delta P$  shows the maximum power per unit membrane surface ( $W$ ) occurs when the differential hydraulic pressure is equal to  $\Delta\pi/2$  (illustrated in Figure 8), hence:

$$W_{\max} = A \frac{\Delta\pi^2}{4} \quad (6)$$

The maximum power per unit flux is obtained at the maximum hydrostatic pressure.

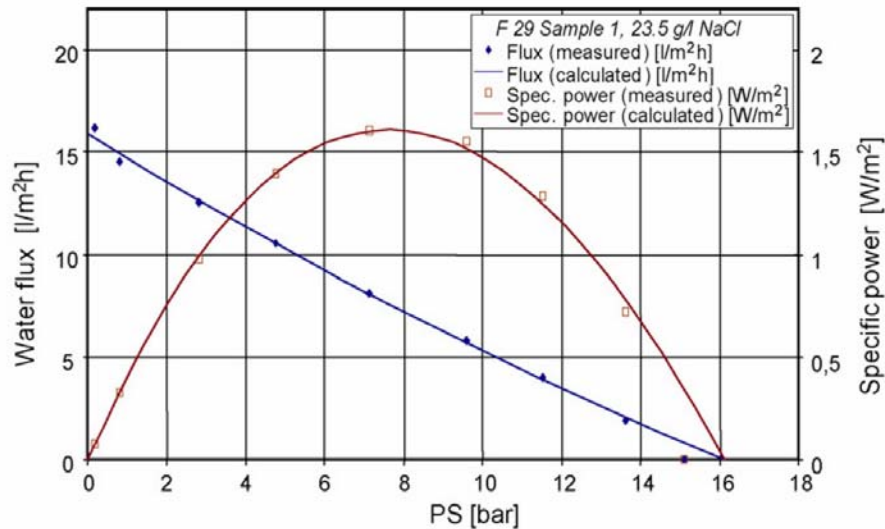

**Figure 8: Example of specific power and flux versus pressure (PS) on the salt water side of the membrane.**  
**Figure taken from [4]**

In more recent times a significant amount of research and development work has been undertaken and funded by Statkraft, the Norwegian state energy company. A prototype plant was built in Norway generating a gross output between 2 – 4 kW [28]. A much larger plant with an output of 1 – 2 MW was being developed at Sunndalsøra, 400 km north of Oslo [29], however Statkraft subsequently announced on the 20 December 2013 that development was being halted due to more favourable economics of other generation technologies [30]. It is also understood that the New Energy and Industrial Technology Development Organisation (NEDO) in Japan is funding work on osmotic power and in particular membranes [31, 32].



**Figure 9: Prototype osmotic power plant, Tofte, Norway. (Photo: Damian Heinisch / Statkraft).**

## 4.2 Desalination / Concentration

To produce desalinated water using a forward osmosis process, there is always at least two steps (the first is FO) with the second step to separate the draw solution / osmotic agent to provide the desalinated water, as simply illustrated in Figure 10. The subsequent step or steps are dependent on the nature and type of draw solution used. It has been suggested that this may involve precipitation, thermal breakdown, membrane separation or magnetism for example. This basic process scheme may also be used for dewatering and/or concentration of the feedwater stream without phase change, so to think of it as just a desalination process is somewhat restrictive.

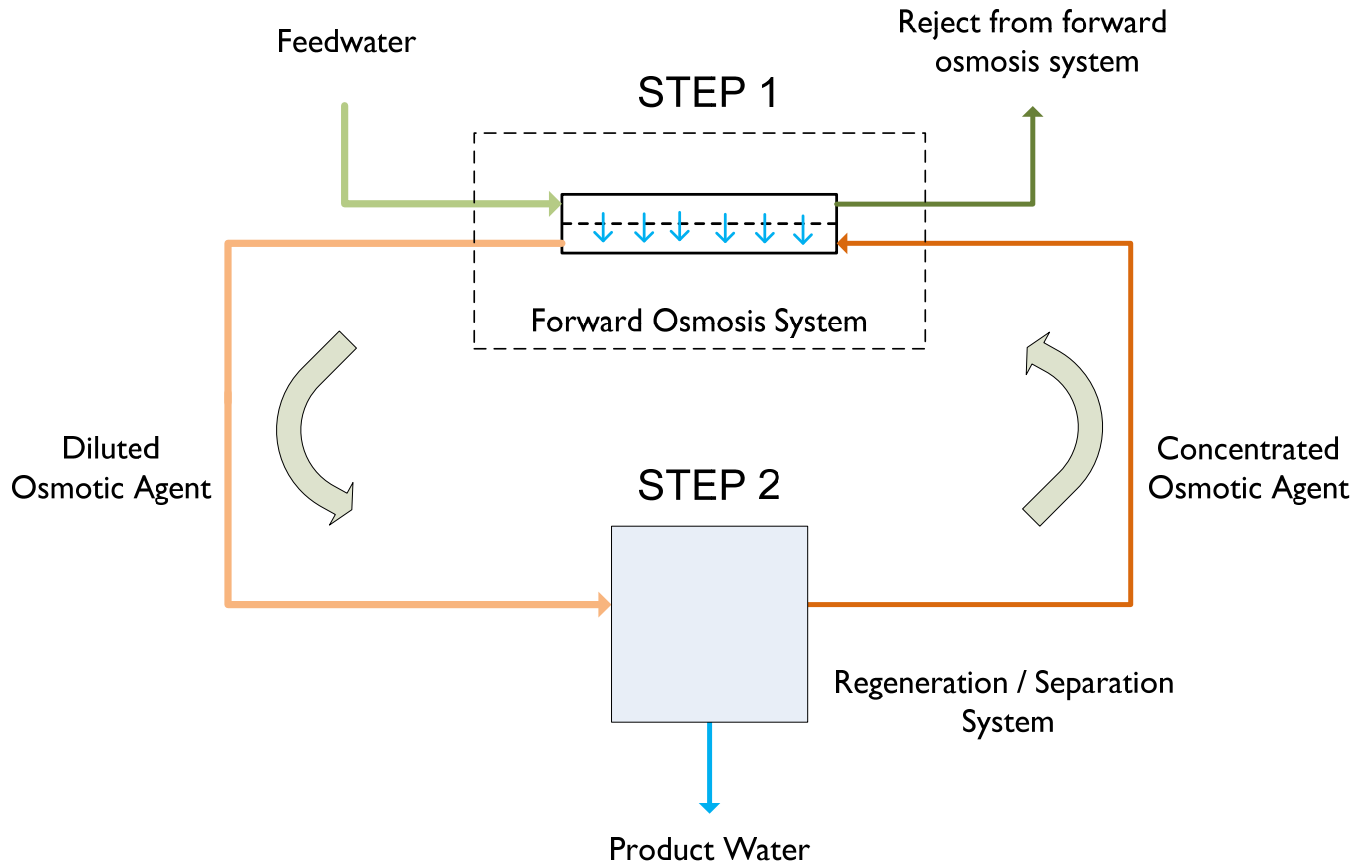

**Figure 10: Simplistic desalination or dewatering / concentration process**

### 4.2.1 FO coupled with thermal regeneration / separation

It is self evident that the second step referred to in Figure 10 could be an evaporation process, where the draw solution is composed of water soluble salts, such as multiple effect distillation or multi stage flash distillation. There are a number of advantages that could be cited for such a process, such as a reduction in scale forming compounds, which would allow an increase in operating temperature and hence depending on configuration a higher gained output ratio (GOR).

Another method is to use thermolytic salts, which when heated decompose into volatile gases, such as  $\text{CO}_2$  and  $\text{NH}_3$  as described by McCutcheon et al. [34,35], illustrated in Figure 11 and subsequently deployed as a demonstration for brine concentration by Oasys Water Inc [36]. The use of thermal decomposition allows the use of very high pressure osmotic solutions since the regeneration step is done by a thermal method rather than a membrane separation, which for practical large scale applications is restricted by the availability of high pressure reverse osmosis membranes.

This process requires heat which is supplied at  $70^\circ\text{C}$  [36], so the economics of the process are clearly dependent on the value of the heat supplied to the process and any subsequent processing required to remove contaminants in the product water such as ammonia from the draw solution and salts that have diffused from the feedwater.

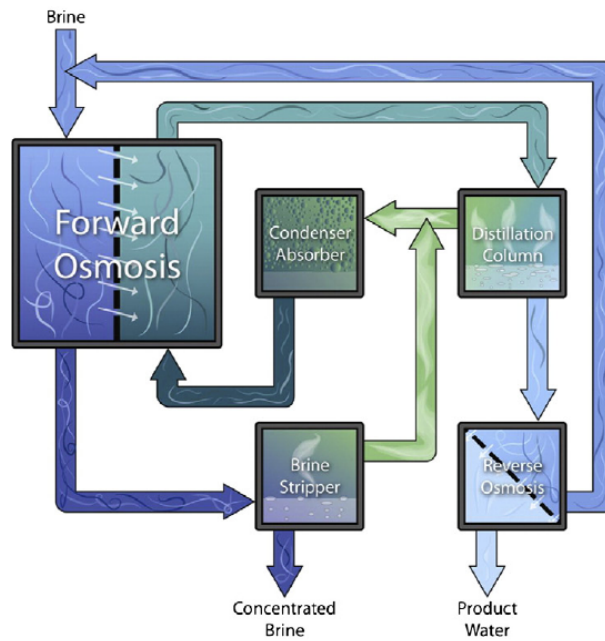

**Figure 11: Ammonia-carbon dioxide forward osmosis process. Taken from [37]**

Inversely soluble polymers may also be used as a draw solution, which on heating become less soluble and may therefore be partially separated from the water using a coalescer, followed by subsequent membrane treatment of the product stream to remove any residual draw solute. Such a system has been developed by Trevi Systems [39] using a low molecular weight copolymer diol solute as the draw solution and is illustrated in Figure 12.

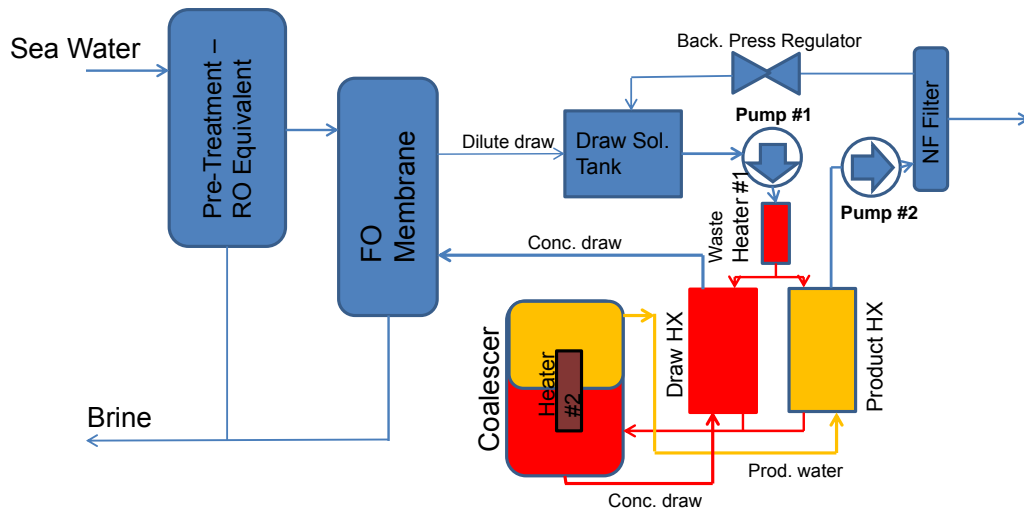

**Figure 12: FO desalination system using inversely soluble copolymer diol draw solution. Taken from [40]**

#### 4.2.2 FO coupled with reverse osmosis

There are numerous applications of this combination of processes, ranging from leachate concentration [38] to desalination [10] and osmotic membrane bio reactors [14]. The basic concept is shown in Figure 13, where there are two steps; the first FO and a second recovery and separation step using RO.

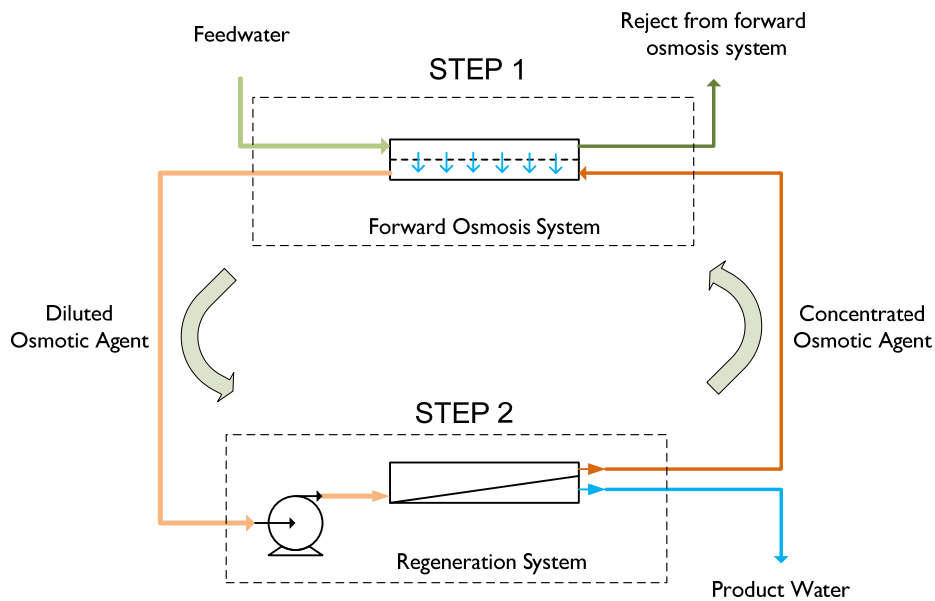

**Figure 13: Basic FO/RO desalination process. Taken from [21]**

The merits and demerits of this process depend on the application, but what is common to them all is the low fouling propensity of the FO step, which is outlined in Section III. The RO step is fed with a draw solution, which should be free of all particulates and membrane foulants given the FO step.



It is claimed [21] that the process when used for desalination has a lower energy consumption than a reverse osmosis plant coupled with advanced pre-treatment including ultra-filtration, when operating on difficult feedwaters. This is based on the different rates of irreversible performance decline for reverse osmosis depending on the feedwater and where the RO step in the FO/RO combination can operate at higher recovery than the RO step alone. Thompson and Nicoll [10] and more recently Nicoll [21] have reported results from three FO/RO plants located in Gibraltar and Oman (Figure 14), two of which operate as commercial desalination plants.



**Figure 14: FO/RO desalination plant (100 m<sup>3</sup>/day) at Al Khaluf, Oman. Taken from [21].**

#### 4.3 Cooling tower make-up water

Evaporative cooling requires significant amounts of good quality water to replace the water lost by evaporation, drift and blowdown. This water may be provided by conventional desalination processes or by the use of tertiary treated sewage effluent, in particular in the Middle East region and India. This process effectively changes the recirculating feed water into a draw solution, so that the make-up water is drawn across a forward osmosis membrane. As there is contamination of the draw solution from ions transferred across the forward osmosis membranes and from possible contaminants in the air, a blow down recovery system is employed to retain the draw solution but remove contaminate species such as monovalent ions. Nicoll et al. describe the development and testing of this system [9], where it is also claimed that the draw solution kills *Legionella pneumophila*, yet the draw solution was non toxic.

The process is effectively osmotic dilution and hence has a very low energy consumption, as illustrated in Figure 16.



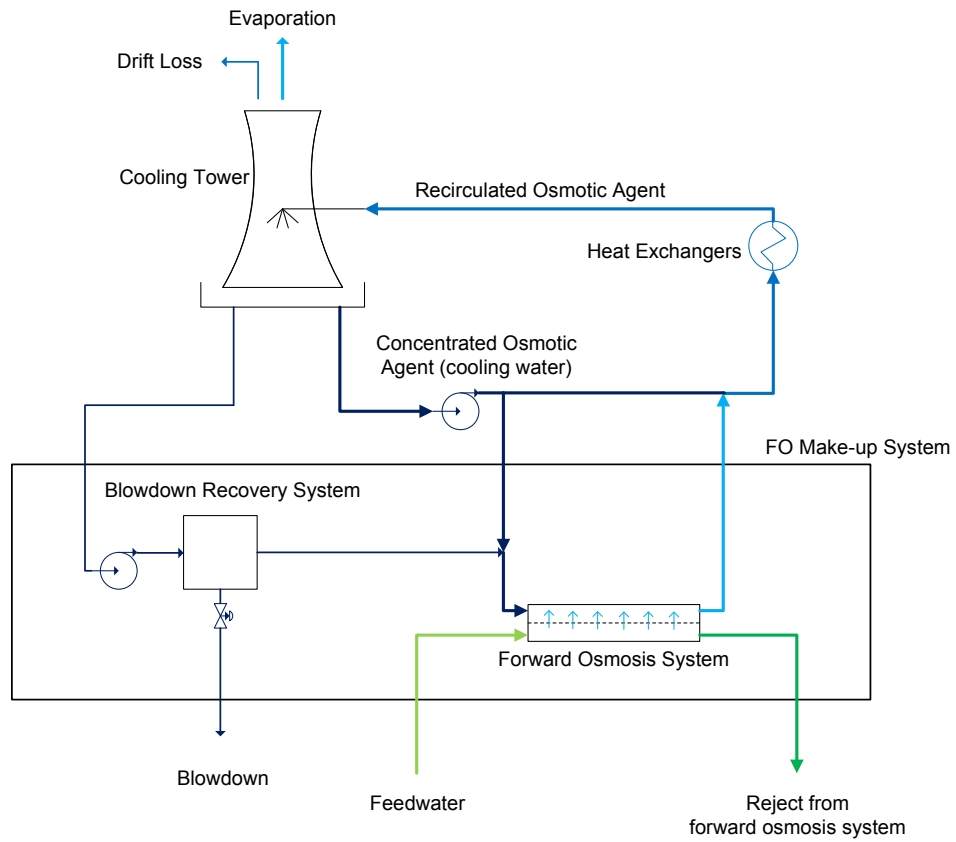

Figure 15: Evaporative cooling make-up water system using forward osmosis. Adapted from [9].

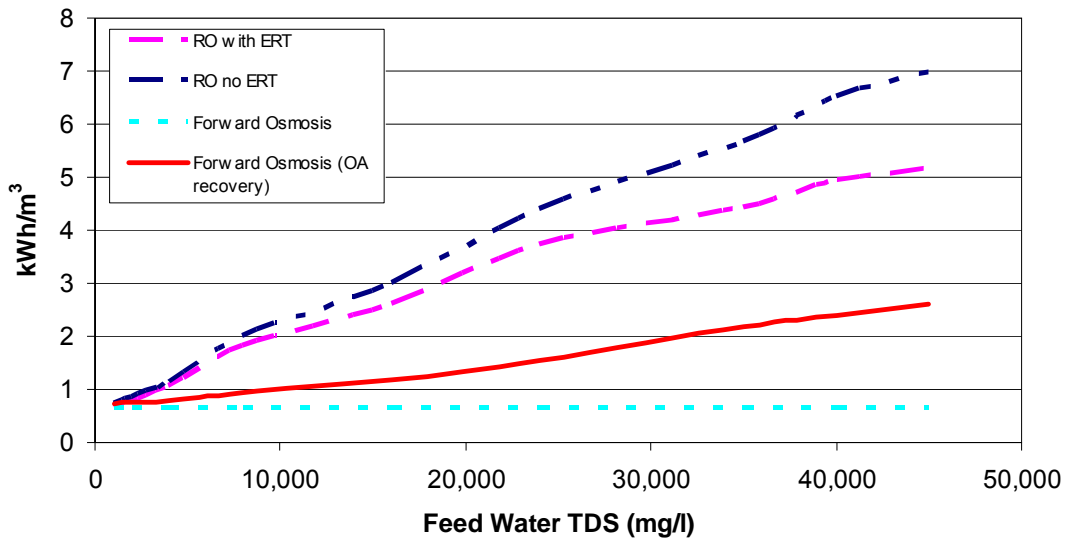

Figure 16: Power consumption of FO relative to RO. Adapted from [41].

#### 4.4 Emergency Drinks

FO can be used to make a sugar drink from a seawater, brackish or impaired water source and is one of the few current commercial applications of FO, which was originally developed for the US military [42]. A sugar solution (dextrose and fructose [43]) is contained within a bag (Figure 17) acts as a semi-permeable FO membrane. In this way when the bag is immersed in an aqueous solution, water gradually flows through the membrane to dilute the drink, which can then be consumed. The process can take a long time, for instance 10 to 12 hours [44] for personal use and as such a number of these pouches need to be deployed to provide a continuous source of water. Larger systems using a replaceable draw solution have also been used in disaster relief situations.



Figure 17: Osmotic hydration bag before use

#### 4.5 Fertigation

This is another example of osmotic dilution (Figure 18), where investigations [45, 46] have been made to dilute liquid fertilisers across a forward osmosis membrane, using brackish water feed. The main issue that has been found is that the concentration of the fertilizer after it has been diluted may be too high and that reverse solute diffusion must be considered in particular when the fertiliser contains nitrogen or phosphorous which may lead to eutrophication in the receiving body.

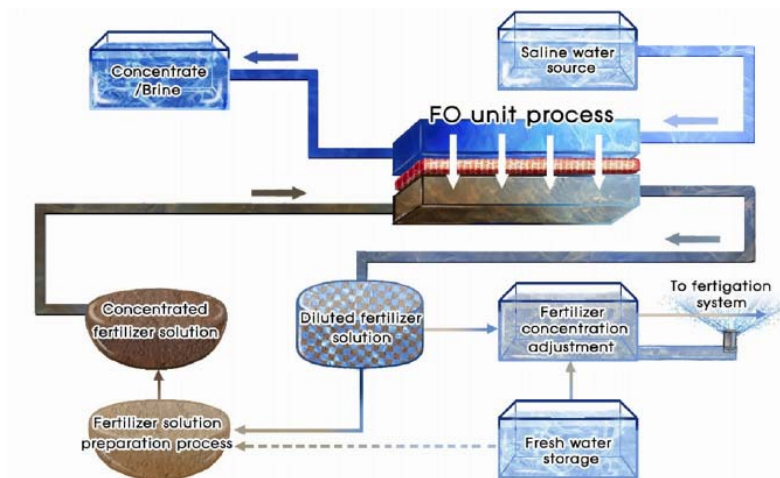

Figure 18: Initial design concept of the fertilizer drawn forward osmosis desalination for direct fertigation. Taken from [45].

#### 4.6 Fracture water make-up using flow-back water

This application [47] has been deployed by Hydration Technology Innovations and Bear Creek Services for the combined concentration of well flow back water, to reduce its volume prior to subsequent treatment/disposal, and the production of water to prepare the fracking solution. The concentrated fracking solution acts simply as the draw solution and the basic process is illustrated in Figure 19, with an example of a mobile unit in Figure 20 .

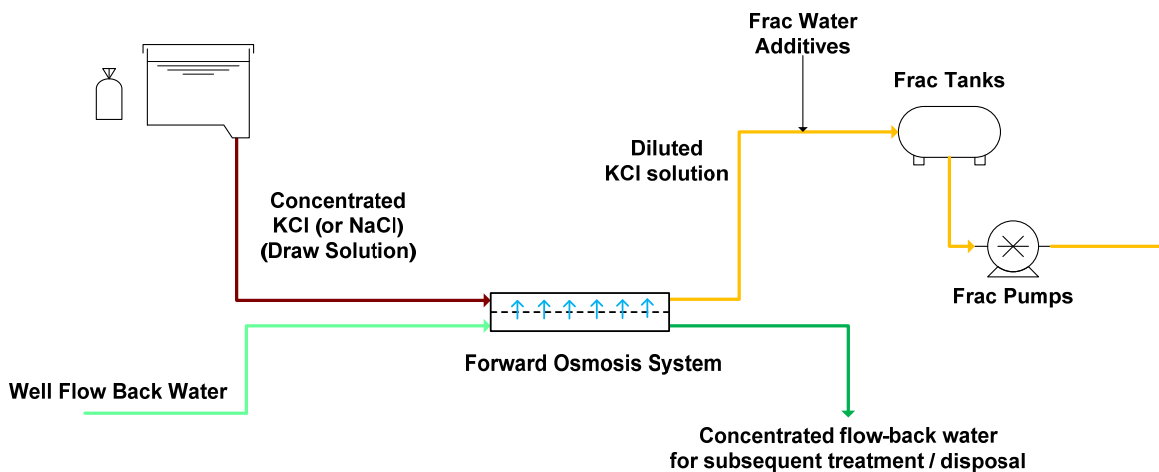

Figure 19: Fracture water preparation using flow back water



Figure 20: Mobile fracture water preparation / flow back water concentration unit. Taken from [47]

## V MEMBRANES

Forward osmosis membranes, conceptually can have similar configurations to conventional ultra filtration or reverse osmosis membranes. They can be flat sheet, plate and frame, spiral wound (Figure 21), tubular or a hollow fibre configuration (Figure 22). In the same way as there are advantages and disadvantages to particular configurations for conventional membranes the same is true for forward osmosis membranes. Unlike conventional membranes a forward osmosis membrane has four flow connections (feed in, concentrated feed out, draw in, dilute draw out), this means in certain applications pressures may be generated by flow and process conditions on the membrane.

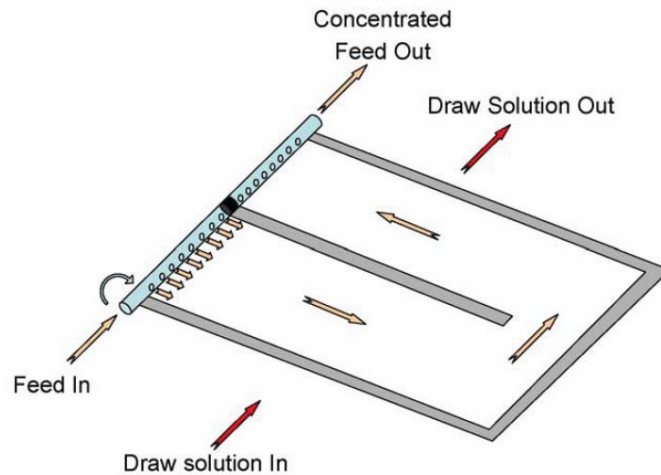

Figure 21: Flow patterns in a spiral-wound module for FO, with the feed solution flowing through the membrane leaves. Taken from [48].

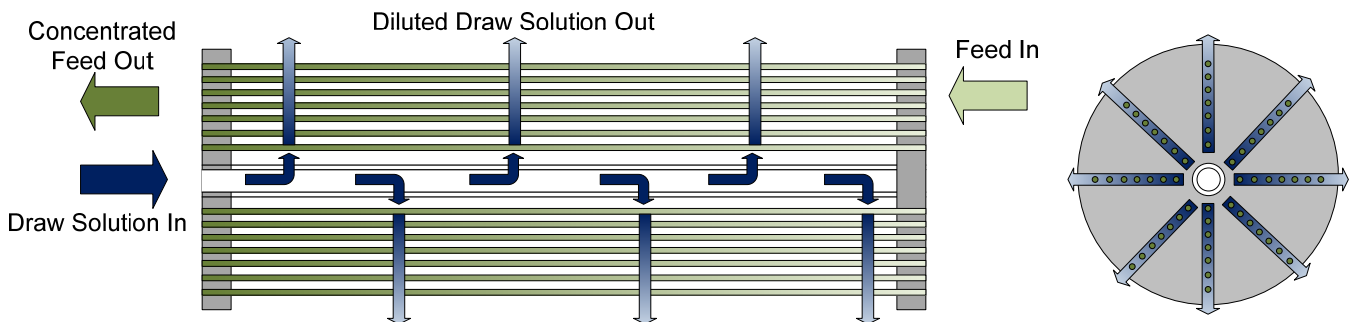

Figure 22: Tubular or hollow fibre membrane element configuration

As is well known in reverse osmosis, membranes of a flat sheet / spiral wound configuration have to be protected from pressures within the internal leaves of the membrane (similar to the conventional product spacer), so that glue line tearing is prevented. A tubular or hollow fibre membrane is not susceptible to this, as it is self supporting and as such hydraulic pressure may be applied to either the outside or inside of the membrane.

At the current time there appears to be only one membrane manufacturer with commercially available membranes (Hydration Technology Innovations), with others in either a development or pre-commercial state, as outlined in Table 2

**Table 2: Forward osmosis membranes commercial status**

Company	Membrane Type	Status
Aquaporin A/S	Aquaporin	Pre-commercial [50]
GKSS Forschungszentrum	Thin film composite	Development [4]
Hydration Technology Innovations	Cellulose acetate, thin film composite	Commercial [51]
Nagare Membranes	Carbon nano tube	Development [52]
Nitto Denko	Unknown	Development [53]
Oasys Water	Thin film composite	Pre-commercial [54]
Porifera	Thin film composite	Pre-commercial [55]
Toray	Thin film composite	Development [31]
Toyobo	Cellulose tri-acetate, hollow fibre	Pre-commercial [33]
Woojgin - CSM	Thin film composite	Development [56]

There have been a number of academic articles published in the last few years covering a wide variety of membrane active layers and support layers, classified into three main categories; phase inversion-formed cellulosic membranes, thin film composite membranes and chemically modified membranes, as summarised by Zhao et al. [57]

The membrane structure for a ‘good’ FO membrane is quite different from a RO membrane in that one of the key parameters that affects performance is internal dilutive concentration polarisation within the porous support layer as outlined earlier. This means that the membrane needs to be as thin as possible, with a porous open structure and low tortuosity. Figure 23 shows the comparison between a membrane specifically produced for forward osmosis applications and another (of the same material) for reverse osmosis.

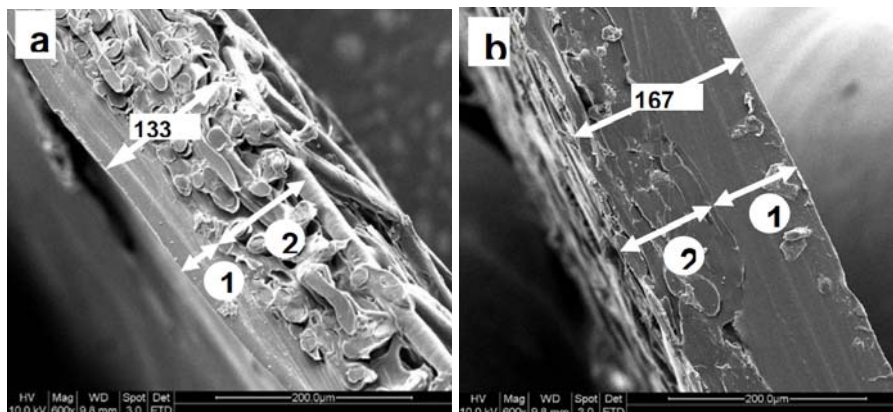

**Figure 23: SEM images of (a) FO CA membrane and (b) a RO CA membrane. (1) is the dense selective layer and (2) is the support layer. Taken from [58]**

## VI DRAW SOLUTIONS

The selection of a suitable draw solution is critical to the successful application of forward osmosis based processes, in particular processes where the draw solution needs to be recovered and its concentration maintained by dosing. Ideally it should have the following characteristics:

- Non toxic
- Low cost
- Easily recoverable / regenerated with a low energy input
- High osmotic pressure at low concentrations
- High solubility
- Low viscosity
- Low reverse solute diffusion (back diffusion of the draw solution to the feed solution)
- Not adversely affected by contamination of ions from the feed solution
- Minimal effect on internal concentration polarisation

This list of desirable characteristics is rather difficult to achieve, so in practice a compromise solution tends to be adopted. The selection and characterisation of draw solutions has been the subject of some research, with inorganic salts, organic salts and synthetic materials (such as solutions containing magnetic nanoparticles) being studied. However in terms of currently deployed commercial or near commercial applications, these have used either inorganic or organic salts.

Achilli et al. [59] investigated inorganic based draw solutions and concluded that in terms of performance  $\text{CaCl}_2$ ,  $\text{KHCO}_3$ ,  $\text{MgCl}_2$ ,  $\text{MgSO}_4$  and  $\text{NaHCO}_3$  ranked highly and from a replenishment cost analysis  $\text{KHCO}_3$ ,  $\text{MgSO}_4$ ,  $\text{NaCl}$ ,  $\text{NaHCO}_3$  and  $\text{Na}_2\text{SO}_4$ . Using their criteria  $\text{KHCO}_3$ ,  $\text{MgSO}_4$  and  $\text{NaHCO}_3$  ranked high on both criteria. However as Achilli et al. point out, the actual selection criteria is dependent on the application and the interaction with the different streams. Some examples of this include reverse solute diffusion that may contaminate or damage a feed stream that is being concentrated using FO or if there are scale precursors in the feed solution that may contaminate the draw solution, although what they don't point out is that antiscalants and antifoulants can be added to the draw solution as disclosed by Sharif et al. [60].

Ge et al. [61] provide a review article of a wide range of different draw solutions that have been reported in the literature.

## V. CONCLUSIONS

This paper should give some insight into the wide range of applications that osmotically driven membrane processes may be applied to, this is far from exhaustive and depends not just on thinking of how it may be applied but also the development of membranes and suitable draw solutions.

Forward osmosis occurs with no external applied pressure and therefore little energy loss, this coupled with an inherently low fouling compared to pressure driven membrane processes, gives some indication of the potential. There are relatively few current commercial applications, but this is expanding.

The basic concept is simple, but the implementation is more challenging and in particular where the draw solution needs to be recovered as is the case for desalination / concentration type applications.

Osmotically driven membrane processes are rather more complex than pressure driven reverse osmosis in that there are complex interactions between the feed and draw solutions and the membrane structure, which can significantly reduce the solvent flux. A low structural parameter of the membrane is particularly important in minimising the effects of internal concentration polarisation both concentrative and dilutive.

Our industry tends to be conservative in outlook and while new technologies are adopted this takes some considerable time. Momentum is now beginning to be gathered with increasing commercial interest in the development of applications and membranes, but this cannot be done in isolation. To accelerate the development of these processes requires champions, whether they be government or private organisations and in this way we will see osmotically driven processes being more widely adopted. We as an industry already have the skills and knowledge to successfully deploy reverse osmosis, after solving the performance issues that were prevalent in the late 80s and early 90s, we can use this expertise in the successful deployment of osmotically driven membrane processes, in all their flavours.

## VI. AUTHOR INFORMATION

Peter Nicoll leads the multi-disciplined technical team at Modern Water plc, where he has been instrumental in the development, design and successful deployment of Modern Water's Forward Osmosis (FO) based technologies. He is the inventor of a number of FO and related processes. A graduate of the University of Glasgow, he is a Chartered Engineer and a Fellow of the Institution of Mechanical Engineers. His previous experience includes Director of Business Development for Fichtner Consulting Engineers Ltd where he was responsible for leading the business development and sales functions. He has extensive broad expertise in all the major desalination processes, having held a number of senior roles, both technically and commercially, at Weir Westgarth.





## VII. REFERENCES

1. Christie B., 'The big idea - Get the salt out', National Geographic, March 2010
2. Nollet J.A., Lecons de Physique Experimentale, Hippolyte-Louis Guerin and Louis-Francios Delatour, Paris, 1748
3. Cohen D., Chemical Processing magazine, Mixing moves osmosis technology forward, October 2004
4. Thorsen T., Holt T., The potential for power production from salinity gradients by pressure retarded osmosis, Journal of Membrane Science, Volume 335, Issues 1–2, 15 June 2009, Pages 103-110
5. Secondary Oil Recovery, US Patent No. US 7,942,205
6. Hickenbottom K.L., Hancock N.T., Nathan, Hutchings R., Appleton E.W., Beaudry E.G., Xu P., Cath T.Y., Forward osmosis treatment of drilling mud and fracturing wastewater from oil and gas operations, Desalination, Volume 312, 1 March 2013, Pages 60-66
7. Beaudry, E.G. and K.A. Lampi, Membrane technology for direct osmosis concentration of fruit juices, Food Technology 44: 121, 1990
8. Nicoll P., Thermal Desalination, European Patent EP2498135 (2013)
9. Nicoll P., Thompson N., Gray V., Forward Osmosis Applied to Evaporative Cooling Make-up Water, Cooling Technology Institute, Houston, USA, February 2012
10. Thompson N., Nicoll P., Forward Osmosis Desalination: A Commercial Reality, Proceedings IDA World Congress, Perth, Western Australia, September 2011
11. The Dow Chemical Company, Osmotic Pressures of Solutions, [http://msdssearch.dow.com/PublishedLiteratureDOWCOM/dh\\_003c/0901b8038003ccc5.pdf?filepath=/609-02133.pdf&fromPage=GetDoc](http://msdssearch.dow.com/PublishedLiteratureDOWCOM/dh_003c/0901b8038003ccc5.pdf?filepath=/609-02133.pdf&fromPage=GetDoc)
12. Lee K.L., Baker R.W., Lonsdale H.K., Membranes for power generation by pressure-retarded osmosis, Journal of Membrane Science, Volume 8, Issue 2, 1981, Pages 141-171
13. Hancock N.H., Cath T.Y., Solute coupled diffusion in osmotically driven processes, Environmental Science and Technology, 43 (2009)
14. Cornelissen E.R., Harmsen D., de Korte K.F., Ruiken C.J., Qin J.-J., Oo H., Wessels L.P., Membrane fouling and process performance of forward osmosis membranes on activated sludge, Journal of Membrane Science 319 (2008) 158–168.
15. Loeb S., Titelman L., Korngold E., Freiman J., Effect of porous support fabric on osmosis through a Loeb–Sourirajan type asymmetric membrane, J. Membr. Sci. 129 (1997) 243–249
16. Zhao S., Zou L., Relating solution physicochemical properties to internal concentration polarization in forward osmosis, Journal of Membrane Science 379 (2011) 459–467.
17. Cath T.Y., Gormly S., Beaudry E.G., Flynn M.T., Adams V.D., Childress A.E., Membrane contactor processes for wastewater reclamation in space: part I. Direct osmotic concentration as pretreatment for reverse osmosis, Journal of Membrane Science 257 (2005) 85–98.
18. Cath T.Y., Adams D., Childress A.E., Membrane contactor processes for wastewater reclamation in space: II. Combined direct osmosis, osmotic distillation, and membrane distillation for treatment of metabolic wastewater, Journal of Membrane Science 257 (2005) 111–119.
19. Lee S., Boo C., Elimelech M., Hong S., Comparison of fouling behavior in forward osmosis (FO) and reverse osmosis (RO), Journal of Membrane Science, Volume 365, Issues 1–2, 1 December 2010, Pages 34-39
20. Holloway R.W., Childress A.E., Dennett K.E., Cath T.Y., Forward osmosis for concentration of anaerobic digester centrate, Water Research, Volume 41, Issue 17, September 2007, Pages 4005-4014

21. Nicoll P., Forward osmosis as a pre-treatment to reverse osmosis, Proceedings IDA World Congress, Tianjin, China, October 2013
22. Lay W.C., Chong T.H., Tang C.Y., Fane A.G., Zhang J., Liu Y. Fouling propensity of forward osmosis: investigation of the slower flux decline phenomenon, *Water Science And Technology*, 2010, v. 61 n. 4, p. 927-936
23. Water Desalination Report, 15 April 2013
24. Pattle R.E., Production of electric power by mixing fresh and salt water in the hydroelectric pile, *Nature* 174 (1954) 660
25. Loeb S., Osmotic power plants, *Science*, 189 (1974)
26. Jellinek H.H.G., Osmotic work I. Energy production from osmosis on fresh water/saline water systems, *Kagaku Kojo* 19 (1975)
27. Al-Mayahi A., Sharif A., Osmotic Energy, Patent EP1660772, June 2007
28. Scramesto, O.S., Skillhagen S.-E. and Nielsen, W.K., 2009. Power production based upon osmotic pressure. In: *Waterpower XVI*, Spokane, WA, USA; 27 – 30 July 2009
29. 2MW Pro Plant Announced, *Water Desalination Report*, 18 February 2013
30. Statkraft halts osmotic power investments, 20 December 2013, <http://www.statkraft.com/media/news/News-archive/2013/Statkraft-halts-osmotic-power-investments/>
31. PG Heisei (Mega-ton Water System) osmotic pressure power generation film formation technology research, [http://www.nedo.go.jp/library/seika/shosai\\_201209/20120000001006.html](http://www.nedo.go.jp/library/seika/shosai_201209/20120000001006.html)
32. PG Heisei (Mega-ton Water System) osmotic pressure power generation system CTA hollow fiber membrane module development, [http://www.nedo.go.jp/library/seika/shosai\\_201209/20120000001041.html](http://www.nedo.go.jp/library/seika/shosai_201209/20120000001041.html)
33. Toyobo, <http://www.toyobo-global.com/news/pdf/2014/05/press20140521.pdf>
34. McCutcheon J.R., McGinnis R.L., Elimelech M., A novel ammonia–carbon dioxide forward (direct) osmosis desalination process, *Desalination* 174 (2005)
35. McCutcheon J.R., McGinnis R.L., Elimelech M., Desalination by ammonia–carbon dioxide forward osmosis: influence of draw and feed solution concentrations on process performance, *Journal of Membrane Science* 278 (2006) 114–123
36. FO takes a big step Forward, *Global Water Intelligence*, Volume 48, Issue 10, April 2012
37. McGinnis R.L., Hancock N.T., Nowosielski-Slepowron M.S., McGurgan G.D., Pilot demonstration of the NH<sub>3</sub>/CO<sub>2</sub> forward osmosis desalination process on high salinity brines, *Desalination*, Volume 312, 1 March 2013, Pages 67-74
38. York R. J., Thiel R. S., and Beaudry E. G., Full-scale experience of direct osmosis concentration applied to leachate management, Sardinia '99 Seventh International Waste Management and Landfill Symposium, S. Margherita di Pula, Cagliari, Sardinia, Italy, 1999
39. Retrograde draw solution key to new FO, *Water Desalination Report*, 25 March 2013
40. Trevi Systems, <http://trevisystems.com/technology/system-process/>
41. Nicoll P, Thompson A, Bedford M (September 2011) 'Manipulated Osmosis Applied To Evaporative Cooling Make-Up Water – Revolutionary Technology', Proceedings IDA World Congress, Perth, Western Australia.
42. *Technology for Humanitarian Action*, edited by Kevin M. Cahill, ISBN 0-8232-2393-0 (2005)
43. Hydration Technology Innovations LLC, Personal Desalination and Water Filters, [http://www.htiwater.com/divisions/personal\\_hydration/index.html](http://www.htiwater.com/divisions/personal_hydration/index.html)
44. Hydration Technology Innovations LLC, Hydropack instructions

45. Phuntsho S., Shon H.K., Hong S., Lee S., Vigneswaran S., A novel low energy fertilizer driven forward osmosis desalination for direct fertigation: evaluating the performance of fertilizer draw solutions, *Journal of Membrane Science* 375 (2011) 172–181.
46. Kim J.E., Phuntsho S., Shon H.K., Pilot-scale nanofiltration system as post-treatment for fertilizer-drawn forward osmosis desalination for direct fertigation, *Desalination and Water Treatment* (2013)
47. Oil Wastewater Treatment & Gas Wastewater Treatment: Lead Story, Hydration Technology Innovations, [http://www.htiwater.com/divisions/oil-gas/lead\\_story.html](http://www.htiwater.com/divisions/oil-gas/lead_story.html)
48. Cath T.Y., Childress A.E., Elimelech M., Forward osmosis: Principles, applications, and recent developments, *Journal of Membrane Science*, Volume 281, Issues 1–2, 15 September 2006, Pages 70-87
49. Hollow fibre membrane element, Statkraft, <http://www.statkraft.com/energy-sources/osmotic-power/technology/membrane-element.aspx>
50. <http://www.aquaporin.dk/156/News/54/aquaporin-ready-to-invest-in-pilot-production.aspx>
51. HTI starts producing thin-film composite FO membrane, *Membrane Technology*, Volume 2012, Issue 7, July 2012, Pages 5-6
52. Personal communication, Nagare Membranes LLC and Modern Water plc, September 2013
53. Nitto Denko/Hydranautics and Statkraft to create osmotic power, Nitto Denko, <http://www.nitto.com/dpage/184.html>
54. Oasys Water Commercializing Forward Osmosis Membrane, *Business Wire*, <http://www.businesswire.com/news/home/20100510005642/en/Oasys-Water-Commercializing-Osmosis-Membrane>
55. Porifera, <http://www.poriferanano.com/technology/forward-osmosis-membrane/>
56. Woongjin Steps Up R&D to Strengthen Membrane Technology, [http://www.csmfilter.com/csm/01com/Company\\_News\\_view.asp?num=2714](http://www.csmfilter.com/csm/01com/Company_News_view.asp?num=2714)
57. Zhao S., Zou L., Tang C.Y., Mulcahy D., Recent developments in forward osmosis: Opportunities and challenges, *Journal of Membrane Science*, Volume 396, 1 April 2012, Pages 1-21
58. Ng, H. Y.; Tang, W.; Forward (Direct) Osmosis: A Novel and Prospective Process for Brine Control, *Water Environment Federation, WEFTEC 2006*
59. Achilli A., Cath T.Y., Childress A.E., Selection of inorganic-based draw solutions for forward osmosis applications, *Journal of Membrane Science*, Volume 364, Issues 1–2, 15 November 2010, Pages 233-241
60. Sharif A. O. and Al-Mayahi A.K., Solvent Removal Process, *European Patent No. EP 1,651,570* (2011)
61. Ge Q., Ling M., Chung T.S., Draw solutions for forward osmosis processes: Developments, challenges, and prospects for the future, *Journal of Membrane Science*, Volume 442, 1 September 2013, Pages 225-237